

TRACOE Twist Plus

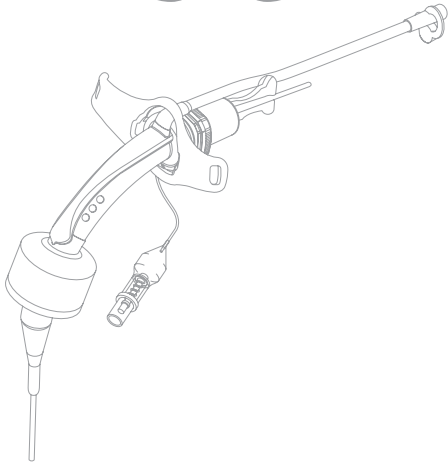

Tracoe Medical GmbH
Reichelsheimer Straße 1 / 3
55268 Nieder-Olm | Germany
info-tracoe@atosmedical.com
www.atosmedical.com

© Coloplast A/S. All rights reserved.
Atos and the Atos Medical logo
are trademarks of Coloplast A/S.

Atos
atosmedical.com

Contents

IMAGES/ 圖片 1

EN - ENGLISH 2

ZHTW - 繁體中文 6

SYMBOLS 9

Image 1

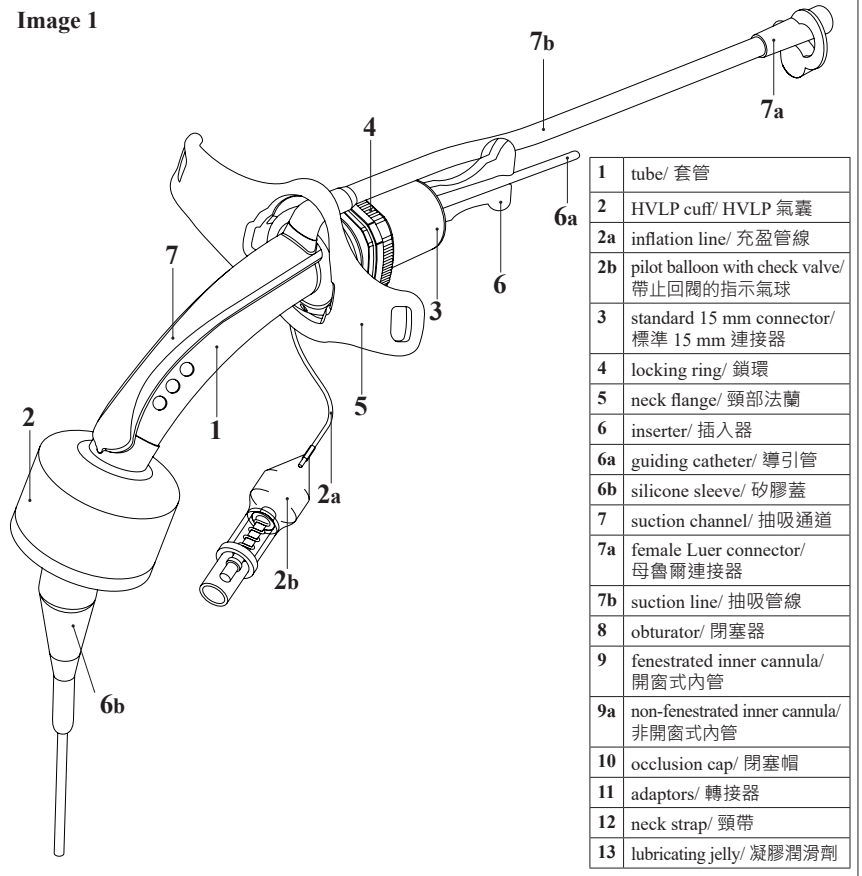

1	tube/ 套管
2	HVLP cuff/ HVLP 氣囊
2a	inflation line/ 充盈管線
2b	pilot balloon with check valve/ 帶止回閥的指示氣球
3	standard 15 mm connector/ 標準 15 mm 連接器
4	locking ring/ 鎖環
5	neck flange/ 頸部法蘭
6	insertor/ 插入器
6a	guiding catheter/ 導引管
6b	silicone sleeve/ 矽膠蓋
7	suction channel/ 抽吸通道
7a	female Luer connector/ 母魯爾連接器
7b	suction line/ 抽吸管線
8	obturator/ 閉塞器
9	fenestrated inner cannula/ 開窗式內管
9a	non-fenestrated inner cannula/ 非開窗式內管
10	occlusion cap/ 閉塞帽
11	adaptors/ 轉接器
12	neck strap/ 頸帶
13	lubricating jelly/ 凝膠潤滑劑

Image 2

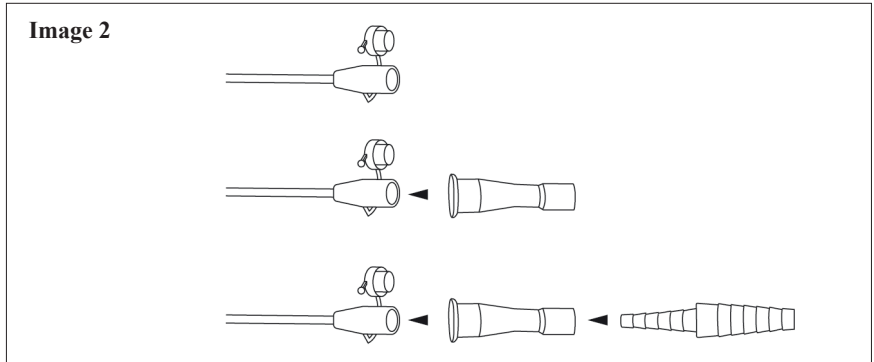

Image 5

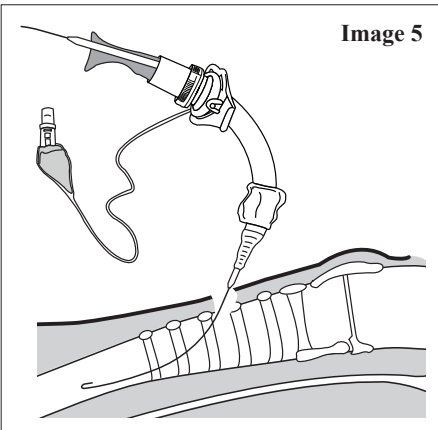

Image 4

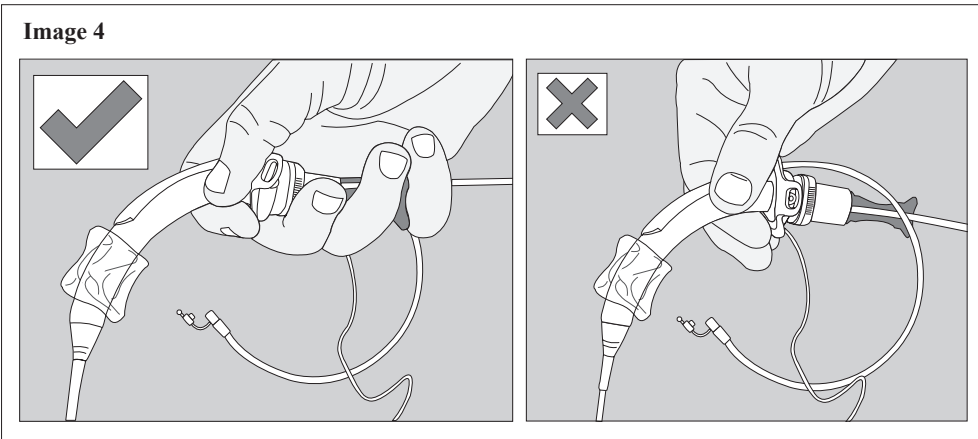
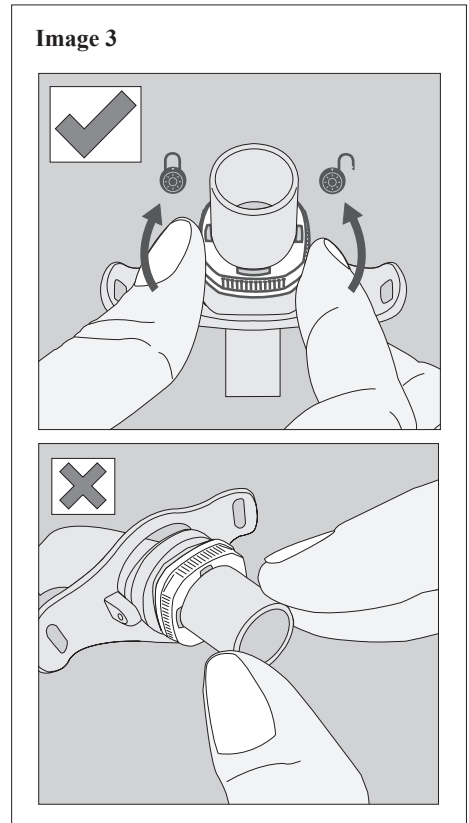
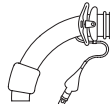
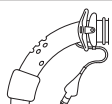
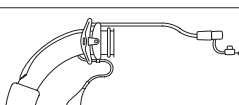
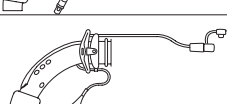
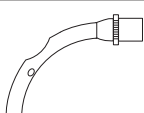
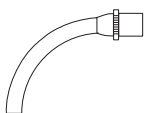

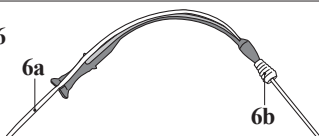



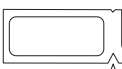
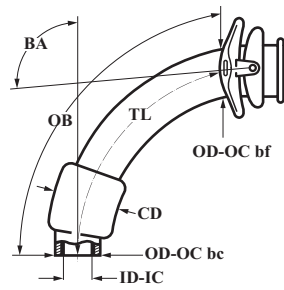

Image 3



Scope of delivery/ 交貨範圍	REF 311-P	REF 312-P	REF 316-P	REF 888- 316-P
	1	-	-	-
	-	1	-	-
	-	-	1	-
	-	-	-	1
9 	-	1	-	1
9a 	2	2	2	2
8 	1	1	1	1
6  6a 6b	1	1	1	1
10 	-	1	-	1
11 	-	-	1	1
12  13 	1	1	1	1

Size Table/ 尺寸表



Size	ID-IC mm	OD-OC bc mm	OD-OC bf mm	TL mm	OB mm	BA °	CD mm
07	7.0	9.8	10.1	85	91	100	26
08	8.0	10.8	11.1	88	95	100	28
09	9.0	11.8	12.1	90	99	100	30
10	10.0	12.8	13.1	92	102	100	32

ID-IC: inner diameter (clear width) at bottom of inner cannula
OD-OC bc: outer diameter at bottom of outer cannula
OD-OC bf: outer diameter of outer cannula behind the flange
TL: length along center line from start of neck flange to bottom of tube
OB: length along outer bend from start of neck flange to bottom of tube
BA: bending angle **CD:** cuff diameter

Image 6/ 圖片 6

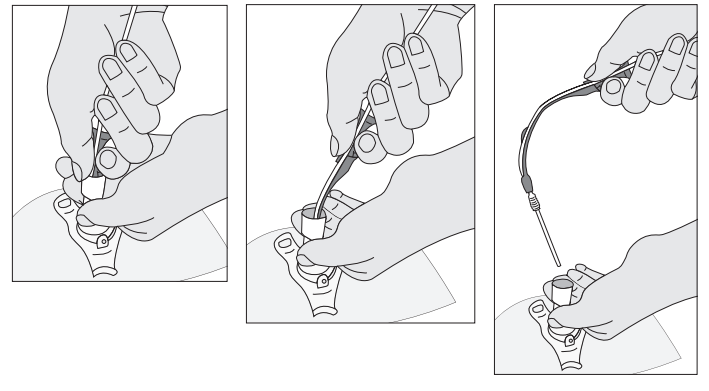

Tracoe Twist Plus tubes are double-lumen tubes. The inner cannula can be removed or exchanged e.g. for cleaning from secretions or obstructions while the outer cannula remains in place. Thus, airway patency can be restored by change of the inner cannula.

The tubes with subglottic suction channel allow to remove the secretions that remain above the inflated cuff.

The fenestrated models permit a proportion of the airflow to be directed towards the upper respiratory tract. If the treatment does not require or allow (e.g. mechanical ventilation) the use of a fenestrated tracheostomy tube, the fenestration can be closed by inserting a non-fenestrated inner cannula.

The 15 mm connector is a standardised component to which other airway management devices (e.g. mechanical ventilator, cough assist, nebuliser etc.) can be connected.

Compared to the usage of an endotracheal tube the anatomical dead space is reduced and there is less need for sedation when using a tracheostomy tube. The risk of long-term complications associated with prolonged endotracheal intubation (e.g. vocal cord injuries, formation of granulation tissue in the laryngeal area etc.) can be prevented when using a tracheostomy tube.

Patient Population: The product is intended for adults and adolescents (≥12 - 21 years).

Clinical Use: The product is intended for mechanically ventilated and self-breathing patients in hospitals, pre-hospitals (EMS), extended care facilities, or outpatient clinics, or home care.

Intended User: The product can be used by medical staff trained in tracheostomy care or individuals trained by professionals.

Indications for Use: The tracheostomy tube is indicated for patients where access to the lower respiratory tract is required by means of a tracheostomy to secure the airway. Tracoe Twist Plus tracheostomy tubes are double-lumen tubes. The inner cannula can be removed and replaced in case of encrustation or obstruction by viscous secretions.

The tracheostomy tube with a high-volume-low-pressure (HVLP) cuff seals the trachea to separate the upper airways from the lower respiratory tract. Therefore, it allows efficient ventilation and reduces influx of subglottic secretions into the lung.

The Minimally Traumatic Insertion System is single use only and is indicated for the insertion of the Tracoe Twist Plus tracheostomy tube using the Seldinger technique. It can be used for the first insertion of the tracheostomy tube after percutaneous dilation tracheostomy or when the tube is changed.

The Tracoe Twist Plus extract tracheostomy tubes with subglottic suction channel and cuff (REF 316-P and REF 888-316-P) are predominantly used for patients producing large amounts of secretions and for whom suctioning of the subglottic space is indicated.

EN - ENGLISH

Instructions for Use Tracoe Twist Plus Tracheostomy Tubes with the Minimally Traumatic Insertion System

The use of Above Cuff Vocalization (ACV) is CE approved only.

NOTE:

• Please read the instructions for use carefully. They are part of the described product and must be available at all times. For your patients' and your own safety, please observe the following safety information.

The illustrations to which the text refers can be found on the illustrated pages at the beginning of these instructions. The numbers indicate product components and refer to the respective illustrations of the product. Symbols and icons used with the product are explained in sections "General Description" and "Functional Description".

1. Intended Use and Indications for Use

Tracoe Twist Plus tracheostomy tubes are indicated for providing tracheal access for airway management. They may be used up to 29 days.

Clinical Benefit: Tracoe Twist Plus tracheostomy tubes provide tracheal access to the lower respiratory tract. The cuffed models, when inflated, can be used to seal the airway (e.g. for mechanical ventilation).

The Tracoe Twist Plus extract tracheostomy tubes can be used for Above Cuff Vocalization (ACV).

The double fenestration of the Tracoe Twist Plus models (REF 312-P, REF 888-316-P) allows a proportion of the airflow to be directed towards the upper respiratory tract.

Single Patient Use and Useful Life: The Tracoe Twist Plus tracheostomy tube is for single patient use with a useful life of 29 days. The device can be cleaned and reinserted in the same patient during this time period.

The device should not be used for more than 29 days beginning from the initial opening of the sterile barrier. This maximum period of use includes both patient and non-patient (e.g. cleaning) use of the device.

Caution:

A prolonged use of the tracheostomy tube for more than 29 days may result in material safety and biocompatibility issues.

2. General Description

The Tracoe Twist Plus tracheostomy tube is made of PU and provides an artificial airway to the lower respiratory tract.

The product includes an outer cannula with 2 or 3 inner cannulas with 15 mm connector, a minimally traumatic insertion system (insertor, guiding catheter with silicone sleeve), a perforated obturator, a fabric neck strap, and lubricating jelly which are supplied together within a sterile bag. Adaptors for use with external suctioning devices are only delivered with the subglottic suctioning models (REF 316-P, REF 888-316-P). The fenestrated models (REF 312-P, REF 888-316-P) also contain an occlusion cap.

The Tracoe Twist Plus tracheostomy tubes are available in different diameters and lengths. The tracheostomy tubes, included with the minimally traumatic insertion system, are cuffed models which are provided with the cuff deflated. The appropriate diameter and length of the tube is determined by the physician.

The tracheostomy tube is radiopaque due to its material.

Clinical use of the device in a MR environment is dependent on the product specifications and is described in chapter "MRI Safety Information".

The tracheostomy tube can be used in combination with medical devices that are approved for invasive ventilation through a tracheostoma and are connected via a standard 15 mm connector. The tracheostomy tubes with the subglottic suction channel can be used with medical devices approved for subglottic suction.

This product is supplied with an information card, including two detachable labels, which contain product specific details. These labels will facilitate reordering of the device and its safe use within a MR environment. The labels can be attached to the patient record.

The image 1 represents the most complex tracheostomy tube model.

1	tube	7	suction channel
2	HVLP cuff	7a	female Luer connector
2a	inflation line	7b	suction line
2b	pilot balloon with check valve	8	obturator
3	standard 15 mm connector	9	fenestrated inner cannula
4	locking ring	9a	non-fenestrated inner cannula
5	neck flange	10	occlusion cap
6	insertor	11	adaptors
6a	guiding catheter	12	neck strap
6b	silicone sleeve	13	lubricating jelly

(1) Tracheostomy Tube:

- All tubes are curved and tapered towards the distal end and feature a round tip at the distal end (inside the patient)
- All tubes are made of a radiopaque material
- REF 311-P: The tube is cuffed
- REF 312-P: The tube is cuffed and fenestrated
- REF 316-P: The tube is cuffed with subglottic suction channel
- REF 888-316-P: The tube is cuffed, fenestrated, and with subglottic suction channel

(2) High-Volume-Low-Pressure (HVLP) Cuff:

- The HVLP cuff (2) is located on the distal end of the tracheostomy tube and directly connected to the inflation line (2a).
- The proximal end of the inflation line includes a pilot balloon (2b), with incorporated self-sealing check valve and a female Luer connector.
- The HVLP-cuff is inflated with air only.
- The pilot balloon (2b) displays the cuff diameter (CD) and size, where appropriate.

(5) Neck Flange:

- The neck flange (5) has a curved form.
- Due to its double-swivel the flange is horizontal and vertical movable
- The product code (REF), clinical size (size), inside diameter (ID), outside diameter (OD), length (TL) of the tube and MR Safety symbol are all indicated on the neck flange.

(6-6b) Minimally Traumatic Insertion System

- The combination of the insertor (6) and guiding catheter (6a) with silicone sleeve (6b) constitute the minimally traumatic insertion system.
- The silicone sleeve bridges the gap between the conical end of the insertor and the distal end of the tube.
- The minimally traumatic insertion system is used for the placement of the Tracoe Twist Plus tracheostomy tube using the Seldinger technique.

(7-7b) Subglottic Suction Channel:

- Tracoe Twist Plus extract tracheostomy tubes (REF 316-P, REF 888-316-P) include a subglottic suction channel (7) on the outside of the tracheostomy tube. The suction opening is placed at the lowest possible position above the cuff.

- The proximal end of the suction channel includes a standard female Luer connector (7a) port for connection to an external accessory device used in subglottic suctioning or for air/oxygen supply for ACV. For subglottic suctioning, additional, adaptors (11) can be used for connection.
- The subglottic suctioning port (7a) can be closed by using the attached cap.

(8) Obturator:

- The perforated obturator (8) has a smooth, round, conical tip at the distal end. The obturator is used for re-insertion of the tracheostomy tube for a tracheostoma.
- Due to its perforation the obturator can be used with the Seldinger technique.

(9-9a) Inner Cannulas:

- The models REF 311-P and REF 316-P are supplied with 2 inner cannulas, one of which is pre-mounted in the outer cannula.
- The fenestrated models REF 312-P and REF 888-316-P are supplied with 3 inner cannulas, one of which is pre-mounted in the outer cannula.
- Each inner cannula has a 15 mm connector with a locking ring (4). The blue locking ring indicates a fenestrated inner cannula (9), and the white ring indicates a non-fenestrated inner cannula (9a).
- REF 311-P and REF 316-P contain 2 non-fenestrated inner cannulas.
- REF 312-P and REF 888-316-P contain 1 fenestrated and 2 non-fenestrated inner cannulas.
- The standardized 15 mm connector (3) is permanently attached to the inner cannula and is intended for connecting the tracheostomy tube to external devices with a female standardized 15 mm connector e.g., connection to mechanical ventilation, HME, speaking valve.

(12) Neck Strap:

- The neck strap (12) is a soft strip of padded fabric that wraps around the patient's neck.
- The ends of the strap include hook-and-loop fasteners that are inserted through the eyelets of the neck flange to secure the tracheostomy tube in position.
- The frequency of change is determined by the physician or healthcare professional.

(13) Lubricating Jelly

- The lubricating jelly (13) can be used for the tube insertion with the minimally traumatic insertion system or obturator.

Supplementary Products:

- Products, which can be used in combination with the Tracoe Twist Plus tracheostomy tubes are listed in section "Supplementary Products".

3. MRI Safety Information

 REF 311-P, REF 312-P, REF 316-P and REF 888-316-P

Nonclinical testing has demonstrated the Tracoe Twist Plus tracheostomy tubes REF 311-P, REF 312-P, REF 316-P and REF 888-316-P are "MR Conditional". A patient with this device can be safely scanned in a MR system meeting the following conditions:

- Static magnetic field of 1.5 Tesla (T) or 3.0 T.
- Maximum spatial field gradient of 1900 gauss/cm (19 T/m).
- Maximum MR system reported whole body averaged specific absorption rate (SAR) of 2 W/kg (normal operating mode) and a maximum whole head specific absorption rate (SAR) of 3.2W/kg.
- Quadrature driven transmit body coil only.
- The neck flange (5) must be secured in place with the neck strap (12).
- The check valve of the tracheostomy tube cuff (2b) must be secured to the skin with medical tape, away from the area of MR diagnostic interest.
- In non-clinical testing, the image artifact, caused by the check valve, extends (radially) up to 107 mm from the check valve when imaged with a gradient echo pulse sequence and a 1.5 T MR system, and up to 113 mm when imaged with a spin echo pulse sequence in a 3.0 T MR system. Therefore, it is recommended to tape the check valve to the patient's skin away from the area of interest.

Warning:

When used in MR imaging:

- Securely fasten the tube, with a metal-free neck strap, to prevent possible movement while in the MR environment.
- Securely affix the check valve away from the area of interest with standard medical tape to prevent movement within the MR environment.
- MR image quality may be compromised if the area of interest is close to the position of the inflation valve.

4. Contraindications

Tracheostomy Tubes:

- The tracheostomy tube cannot be used in conjunction with heat emitting devices, e.g. laser. There is a risk of fire, also toxic gases may form, and the tube may get damaged.
- The HVLP cuff must not be inflated, when a speaking valve or an occlusion cap is used and vice versa.
- Neonates, infants, and children (<12 years).

ACV use:

- Patients with a new tracheostoma (less than 7-10 days after surgical incision).
- Obstructions in the upper airways that can inhibit the airflow and therefore phonation capabilities.
- Obstructions may lead to pressure increase in the trachea and therefore cause a risk of subcutaneous emphysema.
- Patients with surgical emphysema or infections of the tracheal tissue.
- Patients with unilateral or bilateral paralysis of the vocal cords in median position.

5. General Precautions

- When the product is used together with other medical devices, follow their respective instructions for use. Contact the manufacturer if there are any questions, or if assistance is required.
- Safety precautions must be taken in case of complications during the described procedures, in order to provide immediate ventilation through alternative airways, (e.g. trans laryngeal intubation, laryngeal mask). This is recommended to be based on the respective applicable guidelines and standards for patients with difficult airways, e.g. Practice Guidelines for Management of the Difficult Airway (American Society of Anesthesiologists, 2013).
- Optimum oxygen levels must be established in the patient before cannulation or recannulation.
- It is strongly recommended that a ready-to-use spare tube and several inner cannulas are kept at the patient's bedside. Store the spare devices under clean and dry conditions.
- It is also recommended keeping an emergency spare device at the bedside in case of an unplanned tracheostomy tube change, e.g. due to complications, a collapsed tracheostoma or similar. The emergency spare device should be one or two sizes smaller than the device in use.
- The product should be inspected for integrity and function prior to use/insertion. Verify that the tube is free of obstruction and the cuff material is not brittle or torn and can be inflated/deflated,

that there is an absence of kinks, tears or cuts, and there is a stable connection between the tube and the neck flange, etc. If the product is damaged, it should be replaced with a new product.

- The sterile packaging and the outer packaging should be inspected for damage prior to opening. If the packaging is damaged or has been unintentionally opened, the device should not be used.
- While in placement, use or removal of the tracheostomy tube do not use excessive forces.
- Do not use unnecessary force on the tracheostomy tube when connecting to or disconnecting from external devices. This may result in damage of the tracheostomy tube and/or displacement / decannulation.
- Always hold the tracheostomy tube at the base of the 15 mm connector when connecting to or disconnecting from external devices.
- The position of the fenestration should be checked via endoscopy.
- The cuff pressure can change if nitrous oxide (laughing gas) is used as an anesthetic.
- All parts of the cuff inflation system must be free from strain and kinking during measurement of the cuff pressure, otherwise the manometer may show incorrect pressure values.
- Ensure that all allowed objects (e.g. hand-held manometer) used to inflate the cuff are clean (free of dust, visible particles, and contaminants). Any obstruction of the cuff filling system may result in deflation of the cuff which will reduce efficiency of ventilation or protection from aspiration.
- To avoid damage to the cuff and improve ease of insertion, always ensure that the cuff is deflated prior to insertion with the deflated cuff towards the neck flange.
- When a manometer and/or a connection tube is attached to the filling line of an inflated cuff, there will always be pressure compensation between cuff and connected device. This will result in a slight pressure loss in the cuff. If necessary, re-adjust the pressure until it is within the optimal range.
- Water inside the cuff: All HVLVP cuffs have a certain degree of permeability to water vapor. Therefore, condensed water vapor may accumulate inside the cuff. If larger quantities of water inadvertently enter the inflation line, it may lead to improper cuff pressure measurement, cuff pressure adjustment, and cuff deflation. In this case, the tracheostomy tube must be replaced.
- When changing the inner cannula, always ensure that the inflation line of the cuff is not positioned between the inner and outer cannulas as it may get trapped and damaged.
- During mechanical ventilation and frequent changes of the patient's position or manipulation of the tube, the inner cannula may become separated from the outer cannula. Therefore, check the connection of the inner cannula regularly.
- During subglottic suctioning, ensure that negative pressure is not excessive and not applied for an extended period in order to avoid drying out of the subglottic area. Intermittent suction is recommended. Closing the cap of the suction line port after suctioning may reduce the drying-out effect. The suction line may be blocked due to accumulated and/or dried secretions inside the suction line or during suctioning of excessive fluid. If the suction line becomes blocked, follow the instructions in chapter "Subglottic Suction".
- Improper storage conditions may result in product or sterile barrier damage.
- The vital parameters should be monitored regularly by professionals.

6. Warnings

- Do not use this product if the sterile packaging or the outer packaging have been compromised/damaged, e.g. open edges, holes in packaging etc.
- Reprocessing (including re-sterilisation) is not allowed, this may influence the material and function of the product. The products are single use only.
- Modifications of Tracoe products are not allowed. Tracoe will not be responsible for modified products.
- After removing the insertion system, ensure that the silicone sleeve is still located on the guiding catheter. If not, the silicone sleeve (radiopaque) must immediately be removed from the tube or airway.
- During initial placement of a tracheostomy tube immediately stop the ventilation through the upper airways when the cuff of the inserted tracheostomy tube is inflated. This reduces the risk of barotrauma.
- Ensure that the cuff is not punctured by instruments or sharp tracheal cartilage ridges.
- Use only water-soluble lubricating jelly for tracheostomy applications, as oil-based jelly may damage the tube.
- Ensure that the tube does not become obstructed when applying lubricating jelly to the obturator tip.
- Check the position and function of the tube following insertion. Incorrect placement may result e.g. in permanent damage to the tracheal mucosa or minor bleeding.
- Do not move or shift the tube once it is in position, as this may damage the stoma / trachea or lead to insufficient ventilation.
- Do not turn the 15 mm connector, as this may cause the rotation of the inner cannula inside the outer cannula. It may lead to interruption of the air supply or dislocation of the tracheostomy tube. Use the locking ring to loosen and re-lock the inner cannula.
- Never use fenestrated inner cannulas for ventilation.
- To avoid damage to the cuff material it should not be in contact with local anesthetics containing aerosols or any ointments, i.e. dexpanthenol.
- Long-term and excessive cuff pressure above 30 cmH₂O (≈ 22 mmHg) poses a risk of permanent damage to the trachea.
- Only fill the cuff with air. Do not fill the cuff with liquids as this would lead to cuff pressure peaks above 30 cmH₂O.
- Insufficient filling (below 20 cmH₂O) of the cuff could result in insufficient ventilation and/or an increased risk of aspiration, which may result in the worst case in VAP (ventilator associated pneumonia) or aspiration pneumonia.
- When repositioning the patient, while in bed, ensure that the patient does not lie on the pilot balloon, as this could increase the cuff pressure and potentially damage the trachea.
- To prevent damage to the stoma or trachea, ensure that the cuff is deflated (empty) prior to insertion or removal of the tube. If it is not possible to deflate the cuff, cut the inflation line with a pair of scissors and remove the air. In this event, the product is defective and must be replaced.
- During air travel alteration of the cuff pressure may occur. Therefore, ensure permanent cuff pressure control.
- Before deflating the cuff ensure that the patient's upper respiratory tract is unobstructed. When applicable, clear the upper respiratory tract of any secretions through suction or patient coughing.
- Make sure that the correct Luer connectors are used for filling the cuff (transparent) and suctioning (white).
- Make sure that the correct Luer connector (white) is used for ACV.
- Ensure that the tracheostomy tube is free of obstructions which may lead to reduction of the delivered airflow. Therefore, regular suctioning of the secretion inside the tube depending on individual patient's needs (e.g. amount of secretions) is recommended.
- Excessive viscous secretion may lead to dislocation of the tracheostomy tube. Ensure the correct placement of the tube by regularly checking of the tube position and reduce the risk of dislocation by subglottic suctioning of the secretion.
- Use only suction catheters to clear the secretions from the patient's respiratory tract and the tracheostomy tube. Instruments may wedge in the tube and restrict ventilation.
- Regularly check that all connections are secure to prevent an inadvertent disconnection of the tube from external equipment and ensure efficient ventilation.
- Keep the 15 mm connector clean and dry.
- Do not use non-authorized tools to disconnect external equipment from the 15 mm connector, as this might deform the 15 mm connector.

- Occlusion caps/speaking valves must only be used with a deflated cuff to avoid the risk of suffocation.
- During insertion and removal of the tube a need to cough or bleeding may occur.

7. Side Effects

Typical side effects of tracheostomy tubes use include bleeding, pressure points, pain, stenosis, and skin irritation (e.g. due to moisture), granulation tissue, tracheomalacia, tracheoesophageal fistula, increased secretion, and swallowing difficulties. In case of an adverse event please contact a medical professional immediately.

When using ACV, typical side effects include increased secretion, discomfort, hoarseness, coughing, nausea, or laryngeal drying out due to restoring upper respiratory tract (cleaning / tasting / speaking) functionality.

During cuff deflation trials, increased secretion, discomfort, hoarseness, coughing, or nausea may be present.

8. Functional Description

Caution:

- It is strongly recommended that a ready-to-use spare tube and several inner cannulas are kept at the patient's bedside. Store the spare devices under clean and dry conditions.
- It is also recommended keeping an emergency spare device at the bedside in case of an unplanned tracheostomy tube change, e.g. due to complications, a collapsed tracheostoma or similar. The emergency spare device should be one or two sizes smaller than the device in use.
- Safety precautions must be taken in case of complications during the described procedures, in order to provide immediate ventilation through alternative airways, (e.g. trans laryngeal intubation, laryngeal mask). This is recommended to be based on the respective applicable guidelines and standards for patients with difficult airways, e.g. Practice Guidelines for Management of the Difficult Airway (American Society of Anesthesiologists, 2013).

8.1 Preparing the Tube

This is a sterile device, which allows usage within a sterile environment.

The size of the tube and appropriate length is determined by a physician.

The following functions must be checked immediately prior to use: functionality of the cuff, completeness of the device. If the device fails the initial inspection, repeat the procedure with a new device. Do not discard the device and follow instructions provided in section "Returns and Complaints".

A. When using the Minimally Traumatic Insertion System

1. Inspect the sterile packaging to ensure it is undamaged and all components are present.
2. Open the package and visually inspect the device for damages.
3. Check if the tube is free of obstruction, the material is not brittle or torn, the cuff is intact, the inflating or suction lines are not kinked, there are no tears or cuts, the connection between the tube and the neck flange is stable.
4. Check the HVLVP cuff for leakage by inflating with a hand-held manometer, to a pressure of 50 cm H₂O (≈ 36.78 mmHg). Watch the filled cuff for 1 minute to detect leakage by pressure decrease / cuff deflation. If the cuff is tight, remove the air with a syringe. Do not pull any further, e.g. into a vacuum.
5. Verify that the locking ring of the pre-mounted inner cannula can be opened and re-locked without resistance. To open the locking ring of the inner cannula, turn it counterclockwise. To lock the locking ring of the inner cannula, turn it clockwise. Afterwards, make sure that the locking ring is locked properly, and the inner cannula is secured within the outer cannula. Do not remove the inner cannula from the outer cannula.

Caution:

- Make sure to not shift the silicone sleeve when checking the locking mechanism of the inner cannula to prevent a gap in diameter between distal tube end and inserter. In case of a shift the connection can be tightened by carefully pulling back the inserter or the guiding catheter.

6. Check if the pre-assembled silicone sleeve smoothly bridges the gap between the conical end of the inserter and the distal end of the tube. If a gap is visible, the connection can be tightened by carefully pulling back the inserter or the guiding catheter.

Caution:

- **Do not disassemble the pre-assembled tracheostomy tube consisting of insertion system with guiding catheter, tracheostomy tube, and inner cannula.**
- **Do not pull on the tip of the guiding catheter or silicone sleeve. Ensure to take hold of the complete insertion system (inserter, guiding catheter).**
- 7. The silicone sleeve and the end of the tracheostomy tube are then lubricated with a pea-sized amount of the lubricating jelly supplied.
- 8. If appropriate, the neck strap can be attached to the neck flange wings for fixation after insertion of the tube. If a neck strap is to be used, it should be placed below the patient's neck prior to the procedure.

B. When using the obturator for re-insertion

Follow steps 1-5 as described above and proceed as follows:

6. Ensure the obturator inside the tracheostomy tube can be easily moved in and out of the tube.
7. Place the obturator inside the tracheostomy tube.
8. Apply a thin film of lubricating jelly to the protruding part of the obturator at the lower part of the tube including the cuff.
9. If appropriate, the neck strap can be attached to the neck flange wings for fixation after insertion of the tube. If a neck strap is to be used, it should be placed below the patient's neck prior to the procedure.

8.2 Preparing the Patient

Ensure that the patient is optimally pre-oxygenated immediately before insertion or re-insertion. To facilitate insertion, place the patient in a flat supine position with overextended neck, if possible.

8.3 Inserting the Tube

A. When using the Minimally Traumatic Insertion System

The minimally traumatic insertion system is intended for use with the Seldinger technique.

1. The tracheotomized patient has been prepared for cannulation and a Seldinger wire (included in Tracoe expere Sets, not included in P tubes) has been inserted into the stoma canal.
2. Place the tracheostomy tube with insertion system (inserter, guiding catheter) over the Seldinger wire in situ (see Image 5). If using the Tracoe Seldinger wire make sure to stop when the marking on the wire is visible outside of the tube at the end of the guiding catheter outside of the patient.
3. Insert the tube together with the inserter and guiding catheter along the Seldinger wire through the tracheostoma into the trachea. Take care that the tube, inserter handle, guiding catheter, and Seldinger wire remain aligned and fixed with one hand. Any displacement may result in a gap between the silicone sleeve and the tube leading to a difficult or aborted insertion.
4. Gently push the tube forward until the neck flange is in contact with the skin surface.

5. Once in place, secure the tube with one hand and withdraw the inserter and guiding catheter together with the Seldinger wire while the tracheostomy tube remains in position within the trachea (see Image 6).

If the inserter is too difficult to be removed, it can also be removed together with the inner cannula. Therefore, loosen the inner cannula by turning the locking ring counterclockwise. If the inner cannula is removed when removing the inserter, make sure that an inner cannula is then reinserted and locked into place by turning the locking ring clockwise. This can be either the inner cannula from which the insertion system has been removed or a spare inner cannula.

Caution:

- **Do not pull on the guiding catheter separately while the inserter is still inside the tracheostomy tube.** Pull out the inserter always together with the guiding catheter and Seldinger wire or remove the inserter first before pulling on the guiding catheter leaving the tracheostomy tube in place within the trachea.
- After removing the inserter, ensure that the silicone sleeve is still located on the guiding catheter. If the silicone sleeve detaches from the guiding catheter, proceed as follows:
 - o Immediate inspection of the lumen of the tracheostomy tube. If the sleeve remains in the tube, the inner cannula must be replaced with the spare device immediately.
 - o If the silicone sleeve is not visually detectable, it is recommended taking a chest X-ray with the precise localization immediately. Since the silicone sleeve is radiopaque, the X-ray serves as preparation for bronchoscopic removal.

B. With the Obturator

The obturator is perforated and can be used in combination with a Seldinger wire.

1. Prepare the tube and the patient as described in chapter "Preparing the Tube" and "Preparing the Patient".
2. When inserting the tube (with the obturator inside) into the tracheostoma, hold the tube at the neck flange and press the obturator firmly against the 15 mm connector.
3. Gently push the tube forward until the neck flange is in contact with the skin surface.
4. Secure the tube with one hand and remove immediately the obturator after insertion.

8.4 Following Tube Insertion

1. Check if the airway through the tube is unobstructed and if necessary, adjust the position of the tracheostomy tube (e.g. using a bronchoscope).
2. Connect the 15 mm connector of the inner cannula with the respiratory system if ventilation is required.
3. If appropriate: Inflate the cuff of the tracheostomy tube with air through the Luer connector located at the pilot balloon.
4. To prevent tube dislocation, secure the tube in place with the neck strap.
5. It is recommended that a dressing is placed between the tracheostoma and the neck flange to prevent irritation of the skin underneath the flange.
6. Re-check the cuff pressure to make sure that the cuff has not been damaged during the insertion.

8.5 Inflating the Cuff

Option 1: In place of a standard syringe for inflating the cuff, we recommend the use of a hand-held manometer. Adjust the cuff pressure to the individual ventilation therapy and check it at regular intervals. Typically, the pressure should be between 20 cmH₂O (≈ 15 mmHg) and 30 cmH₂O (≈ 22 mmHg).

Option 2: Use a Tracoe Smart Cuff Manager to maintain the cuff pressure within the range of 20 to 30 cmH₂O through passive control. Attach the male Luer of the Tracoe Smart Cuff Manager to the female Luer of the check valve of the tracheostomy tube. Inflate the Tracoe Smart Cuff Manager using a standard syringe according to the respective IFU.

Caution:

- When repositioning the patient, while in bed, ensure that the patient does not lie on the pilot balloon, as this could increase the cuff pressure and potentially damage the trachea.

8.6 Connecting/Disconnecting External Equipment

To connect to external equipment or accessories (e.g. ventilator) firmly hold the base of the 15 mm connector and gently push the connection end of the external device until it is securely attached to the tracheostomy tube. If in doubt, twist the connection end on and off several times, in order to confirm the amount of force needed to ensure the connection is secure and the external device can be easily disconnected at a later time.

If disconnection is difficult, use a standardized disconnect wedge (not supplied) to uncouple the tracheostomy tube from external equipment or accessories by sliding the opening of the disconnect wedge between the 15 mm connector and external device until the two devices are separated, see chapter "Supplementary Products".

Caution:

- Do not use unnecessary force on the tracheostomy tube when connecting to or disconnecting from external devices. This may result in damage of the tracheostomy tube and/or displacement/decannulation.

8.7 Subglottic Suction

1. To perform intermittent suctioning, remove the cap of the subglottic suction line Luer connector.
- 2a. Manual suctioning can be carried out using a syringe.
- 2b. An active suction device can be connected using the adaptors (see Image 2).
3. Following subglottic suctioning, reseal the suction line Luer connector with the cap.

Caution:

- If the suction channel is obstructed, it can be cleared by inflation of air/ oxygen (recommended 3-6 l/min; max. 12l/min) or it can be rinsed with saline solution (recommended 2-3 ml). Do not exceed the recommended limits and take care of the patient's individual tolerability. The following side-effects could occur: Accumulation of potentially contaminated secretions, discomfort, nausea and retching, excessive secretions.
- Before rinsing the suction channel, make sure that the cuff is sufficiently inflated.
- Remove the applied saline immediately after rinsing the suction channel.
- If the suction channel does not get cleared, the tube must be changed.

8.8 Above Cuff Vocalisation

Caution:

- ACV must be performed by professional personnel.

ACV is used to provide phonation capabilities for the patient. Therefore, it must be adjusted to the individual patient's needs and abilities. It is essential that the patient is instructed and involved in every step of ACV to ensure cooperation and good results during the application. Before using ACV ensure that the patient is wearing a tracheostomy tube with permanently inflated cuff and does not tolerate cuff deflation. If needed, air can be humidified before inflation through the subglottic suction line which may prevent the laryngeal mucosa from drying out.

1. Explain the planned procedure to the patient. Indicate possible adverse reactions and clarify patient's questions.
2. Verify that the upper airways are not obstructed.
3. Clear the subglottic space from secretions using subglottic suctioning.
4. Verify that the suction channel is not obstructed.
5. Connect the adjustable air or oxygen supply via a fingertip connector to the female Luer connector of the subglottic suction line. Alternatively, other devices for interruption of the permanent airflow may be used (e.g. Y-connector).
6. Inflate air slowly into the upper airways of the patient starting with 1 l/min and slowly rising to a typical flow rate of 3-6 l/min depending on the patients' requirements. To may reduce laryngeal mucosa from drying out, flow rates must not exceed 12 l/min. Use the fingertip connector to limit the air flow time. This timeframe should be adapted to the patient's exhaling rhythm. Adjust airflow and time within the comfort zone of the patient.
7. Monitor the patient's reaction and adjust parameters (flow and time of airflow) as necessary.
8. When the session is finished, turn off the air flow and disconnect the equipment from the subglottic suction line connector and replace the cap.

Caution:

- The airflow through the upper airways may irritate the patient or may lead to increased secretion, coughing, nausea, or retching.
- If the voice sounds gruff, repeat subglottic suction to clear the airway.
- Adjust the duration of a single ACV session to the capabilities/endurance of the patient.
- Use short sessions of ACV to prevent drying of the laryngeal mucosa.
- Regularly monitor patients with tracheostoma by medically trained staff.

8.9 Deflating the Cuff

Before deflating the cuff, ensure that as little secretions as possible enter the lower respiratory tract, e.g. by subglottic suctioning and/or suctioning through the tube. To deflate the cuff, attach a syringe (with the plunger pushed in) to the female Luer connector of the pilot check valve. Pull the plunger back until air is removed from the cuff. Do not pull any further, e.g. into a vacuum. The cuff must be deflated (empty) prior to removal of the tracheostomy tube.

Caution:

- When removing the air from the cuff, pay attention to the volume of the air removed. This serves as a reference for the integrity of the system for further cuff inflation.

8.10 Changing the Inner Cannula

If viscous secretion collects in the inner cannula and cannot be suctioned, thus impeding the airflow, replace the inner cannula with a new or cleaned inner cannula.

1. Loosen the inner cannula by turning the locking ring counterclockwise and remove it.
2. If the product is damaged, do not further use the inner cannula, do not discard the inner cannula and follow instructions in chapter "Returns and Complaints".
3. Once a new inner cannula has been inserted into the outer cannula, lock in place by turning the locking ring clockwise until it clicks into place.

Caution:

- When inserting the inner cannula, ensure that the inflation line of the cuff is not lying between the inner and outer cannulas, otherwise it may get trapped and damaged.

8.11 Removing the Tube

In case of a tube change, prepare the replacement tube as described in chapter "Preparing the Tube". Before removing the tube, prepare the patient as described in chapter "Preparing the Patient".

1. Deflate the cuff (see chapter "Deflating the Cuff").
2. Secure the neck flange, while loosening the neck strap.
3. Firmly hold the neck flange and gently pull the tracheostomy tube from the stoma. If necessary, suctioning of secretions through the tube may be helpful to prevent infiltration into the lower respiratory tract.
4. Following removal, the tube should be cleaned as soon as possible to prevent encrustation of fluids.
5. If the product is damaged, do not further use the tube, do not discard the tube and follow instructions in chapter "Returns and Complaints". In case of a tube change, follow the instructions described in chapters "Inserting the Tube", "Following Tube Insertion", "Inflating the Cuff" and "Connecting/Disconnecting External Equipment" after removing the tube.

9. Care and Cleaning

Caution:

- The device should not be used for more than 29 days beginning from the initial opening of the sterile barrier.
- The minimally traumatic inserter and guiding catheter are single-use and not allowed to be cleaned and reused.
- This maximum period of use includes both patient and non-patient (e. g. cleaning) use of the device.
- For reasons of hygiene and to avoid a mix-up when reassembling the tube afterwards only one outer cannula together with the corresponding inner cannula must be cleaned together.
- The product should be inspected for integrity and function prior to re-insertion

Cleaning of the tracheostomy tube and obturator is intended to remove any bodily fluids or encrustation that may inhibit its clinical use.

Please take care to hold the outer cannula after cleaning at its neck flange, the inner cannula at the 15 mm connector and the obturator at its handle.

The following instruction for manual cleaning applies to all Tracoe Twist Plus models and sizes:

1. Loosen the inner cannula from the outer cannula
2. To clean the tube (outer and inner cannula) and obturator, rinse the devices separately under lukewarm (max. 40 °C/104 °F) potable water until they are visibly clean and free of encrustations.
3. Particular attention should be taken to ensure the inside of the tube and as appropriate, the subglottic suction are thoroughly rinsed.
4. For removal of residual debris brushes or swabs offered by Tracoe can be used, see "Supplementary Products".
5. Alternatively, the Tracoe cleaning products (see "Supplementary Products") can be used in accordance with their respective instructions for use.
6. After cleaning, rinse the tube with potable or distilled water.
7. If the tube is not visually clean after rinsing then:
 - repeat rinsing until it is visibly clean, or
 - repeat the cleaning using the Tracoe cleaning products, or
 - safely dispose of the tracheostomy tube.

8. All areas of the tube and obturator should be inspected, in adequate light, to ensure the device is free of contaminants and encrustations.

9. Following the cleaning process, place the tube and obturator on a clean lint-free dry towel and air dry in an area free of airborne contaminants.

10. The outer cannula, the inner cannula and the obturator are considered dry when there is no visual evidence of residual water. Please check, that the inner of the cuff is dry.

11. Finally, a visual and functional inspection prior to re-insertion should be performed to verify that the tube and obturator are not damaged (also see chapter "Preparing the Tube").

Caution:

- The tracheostomy tube (outer and inner cannulas) and obturator should be cleaned immediately after removal from the stoma to prevent drying of soil and contaminants.
- When cleaning, take care not to damage the cuff or the inflating line.
- When immersing a cuffed tube in a cleaning reagent solution, it is recommended to not submerge the pilot balloon in the solution.
- The frequency of cleaning must be defined by the physician but must not exceed the allowed frequency.
- It is recommended to clean the tracheostomy tube on a daily basis. Maximum allowed cleaning cycles within 29 days are 29 for the outer cannula and 35 for the inner cannula, otherwise biocompatibility and material stability could be impaired.
- The tubes must never be cleaned using agents or procedures which are not specified in this instruction.
- The tracheostomy tube is single patient use. Therefore, it must be returned to the same patient.
- Failure to clean the device properly can result in damage to the tube, an increase in air resistance due to obstructions, or irritation/inflammation of the tracheal stoma.
- Since the upper respiratory tract is never free from microorganisms, even in healthy individuals, we do not recommend the use of disinfectants.

10. Storage

- a) Store the Tracoe products in their original packaging according to the conditions displayed on the packaging. Do not heat the products to a temperature above 60°C.
- b) Store cleaned tracheostomy tubes in a clean covered container, within a clean and dry location, and away from sunlight. Re-insert the tracheostomy tube as soon as possible. Improper storage conditions may result in tube damage or contamination. Do not store the cleaned devices for more than 29 days from first use.

11. Packaging

The product is provided sterile (with ethylene oxide) which allows application under sterile conditions. Tracoe tracheostomy tubes do not require a sterile environment during normal use or cleaning.

12. Disposal

Used products are to be disposed of in accordance with national regulations, waste management plans, or clinical procedures governing biohazardous waste materials, e.g. the direct disposal in a tear and moisture-resistant and secure bag or container, which is routed to the local waste disposal system for contaminated medical products. For further recommendations, contact your hygiene officer in health facilities, or the local waste management for homecare use.

13. Returns and Complaints

If you have a complaint about the device, please contact complaint.se@atosmedical.com. If it is involved in a reportable incident, as defined in local medical device legislation, additionally contact the appropriate regulatory body in the country of use.

14. Supplementary Products

Tracoe Twist Plus Tracheostomy Tubes with Minimally Traumatic Insertion System are also available as Tracoe Experc Set in combination with Tracoe Experc Dilation Set.

The Tracoe Seldinger Guide Wire is part of the above-mentioned sets. It is also available separately with or without guiding catheter.

14.1 Recommended Products:

- Tracoe Twist Plus Spare inner cannulas
- Syringes with standard male Luer connector
- Cuff pressure monitors for HVLP cuffs with standard male Luer connector
- Tracoe Smart Cuff Manager
- Sterile water-soluble lubricating jellies for tracheostomy applications
- Neck straps
- Disconnecting wedges for tracheostomy / endotracheal tubes with 15 mm connectors
- Humid Moist Exchangers (HME) with a standard male 15 mm connector

14.2 Optional Products:

- Speaking valves and occlusion caps with a standard male 15 mm connector
- Cleaning agents offered by Tracoe
- Cleaning accessories (e.g. swabs, brushes, tub) offered by Tracoe
- Tracoe Shower Guard
- Dressings and compresses
- Protective textiles (e.g. bibs, scarves, roll-necks)

15. General Terms and Conditions

The sale, delivery and return of all Tracoe products shall be affected exclusively on the basis of the valid General Terms and Conditions (GTC), which are available either from Tracoe Medical GmbH or on our website at www.tracoe.com.

ZHTW - 繁體中文

使用說明

Tracoe Twist Plus 氣切套管 (帶微創插入系統)

氣囊上方發聲 (ACV) 使用僅經 CE 核准。

備註：

請仔細閱讀使用說明。使用說明是所描述產品的一部分，必須隨時可取得。為了您的患者和您自身的安全，請遵守以下安全資訊。

文中提到的插圖可在本說明開頭的插圖頁面 (折頁) 上找到。數字表示產品組件，並參考產品的相應插圖。與產品一起使用的符號和圖示在「概述」和「功能描述」部分有解釋。

1. 預期用途和使用適應症

Tracoe Twist Plus 氣切套管適用於提供氣道管理的氣管通道。最多可使用 29 天。

臨床效益： Tracoe Twist Plus 氣切套管可提供通往下呼吸道的氣管通道。氣囊式型號在充氣時可用於密封氣道 (例如用於機械通氣)。Tracoe Twist Plus 套管是雙腔套管。可以移除或更換內管，例如在外管保持原位時清潔分泌物或阻塞物。因此，可透過更換內管來恢復氣道通暢。帶聲門下抽吸通道的套管可清除遺留在充盈氣囊上方的分泌物。開窗式型號允許氣流的一部分流向上呼吸道。如果治療不需要或不允許 (例如機械通氣) 使用開窗式氣切套管，則可透過插入非開窗式內管來關閉開窗。15 mm 連接器是標準化組件，可連接其他呼吸道管理裝置 (例如機械呼吸器、咳嗽輔助器、霧化器等)。

相較於使用氣管內管，使用氣切套管時，解剖死腔減少了，對鎮靜劑的需要也較少。使用氣切套管時，可以預防與長期氣管插管相關的長期併發症的風險 (例如聲帶損傷、喉區內芽組織的形成等)。

患者群體： 本產品適用於成人和青少年 (≥ 12-21 歲)。

臨床應用： 本產品適用於醫院、院前 (EMS)、長照護理設施或門診診所或家庭護理中的機械通氣和自主呼吸患者。

預期使用者： 本產品可以由受過氣管造口護理訓練的醫療人員或由專業人員訓練的個人使用。

使用適應症： 氣切套管適用於需透過氣管造口術進入下呼吸道以確保氣道通暢的患者。Tracoe Twist Plus 氣切套管是雙腔套管。在出現結殼或被黏稠分泌物阻塞的情況下，可將內管取出並更換。

具有大容量低壓 (HVLP) 氣囊的氣切套管密封氣管，將上呼吸道與下呼吸道分開。因此，它可以有效通氣，減少聲門下分泌物進入肺部。

微創插入系統僅限單次使用，適用於使用 Seldinger 技術插入 Tracoe Twist Plus 氣切套管。它可用於經皮擴張氣管切開術後首次插入氣切套管，或在更換套管時使用。

Tracoe Twist Plus Extract 氣切套管帶有聲門下抽吸通道和氣囊 (REF 316-P 和 REF 888-316-P) 主要用於產生大量分泌物的患者，並且適用於抽吸聲門下空間的患者。Tracoe Twist Plus Extract 氣切套管可用於氣囊上方發聲 (ACV)。

Tracoe Twist Plus 型號 (REF 312-P、REF 888-316-P) 的雙開窗結構可將氣流的一部分引導到上呼吸道。

單一患者使用和使用壽命： Tracoe Twist Plus 氣切套管適用於單一患者，使用壽命為 29 天。在此期間，可清潔本裝置並重新插入同一位患者體內。

從最初打開無菌屏障開始，本裝置的使用時間不應超過 29 天。此最長使用期間包括患者和非患者 (例如清潔) 使用本裝置。

注意：

使用氣切套管超過 29 天可能導致材料安全性和生物相容性問題。

2. 概述

Tracoe Twist Plus 氣切套管由 PU 製成，提供通往下呼吸道的人工氣道。

此產品包含一個帶有 2 或 3 個內管和 15 mm 連接器的外管、一個微創插入系統 (插入器、帶砂膠蓋的導引管)、一個開孔式閉塞器、一條布質頸帶，以及一個無菌袋內附帶的凝膠潤滑劑。僅有聲門下抽吸型號 (REF 316-P、REF 888-316-P) 附送與外部抽吸裝置搭配使用的轉接器。開窗式型號 (REF 312-P、REF 888-316-P) 也包含閉塞帽。

Tracoe Twist Plus 氣切套管有不同的直徑和長度可供選擇。氣切套管，包含在微創插入系統中，是帶氣囊的型號，並在未充氣的狀態下提供。套管的適當直徑和長度由醫生決定。

氣切套管由於其材料而具有放射線不透性。

本裝置在磁共振環境中的臨床使用取決於產品規格，詳情請參閱「磁共振 (MRI) 安全資訊」章節。

氣切套管可與經核准可透過氣管造口進行侵入性通氣的醫療器械結合使用，並可透過標準的 15 mm 連接器連接。帶聲門下抽吸通道的氣切套管可用於核准用於聲門下抽吸的醫療器械。

本產品附有資訊卡，包括兩個可撕下的標籤，其中包含產品的具體細節。這些標籤將有助於裝置的重新訂購及其在磁共振環境中的安全使用。標籤可以附加到患者紀錄中。

圖 1 代表最複雜的氣切套管型號。

1	套管	7	抽吸通道
2	HVLP 氣囊	7a	母魯爾連接器
2a	充盈管線	7b	抽吸管線
2b	帶止回閥的指示氣球	8	閉塞器
3	標準 15 mm 連接器	9	開窗式內管
4	鎖環	9a	非開窗式內管
5	頸部法蘭	10	閉塞帽
6	插入器	11	轉接器
6a	導引管	12	頸帶
6b	砂膠蓋	13	凝膠潤滑劑

(1) 氣切套管：

- 所有套管都彎曲並朝向遠端逐漸變細，並在遠端 (患者體內) 具有圓形尖端
- 所有的套管都是由放射線不透性材料製成
- REF 311-P：套管有氣囊
- REF 312-P：套管有氣囊且為開窗式
- REF 316-P：套管有帶聲門下抽吸通道的氣囊
- REF 888-316-P：套管有氣囊、為開窗式，並帶有聲門下抽吸通道

(2) 大容量低壓 (HVLP) 氣囊：

- HVLP 氣囊 (2) 位於氣切套管的遠端，並直接連接到充盈管線 (2a)。

- 充盈管線的近端包括指示氣球 (2b)，其中包含自密封止回閥和母魯爾連接器。
- HVLP 氣囊僅用空氣充氣。
- 在適當情況下，指示氣球 (2b) 顯示氣囊直徑 (CD) 和大小。

(5) 頸部法蘭：

- 頸部法蘭 (5) 具有彎曲形狀。
- 由於其雙旋轉設計，頸部法蘭可水平和垂直移動
- 產品代碼 (REF)、臨床尺寸 (size)、內徑 (ID)、外徑 (OD)、長度 (TL) 以及 MR 安全符號都標示在頸部法蘭上。

(6-6b) 微創插入系統

- 插入器 (6) 和導引管 (6a) 與矽膠蓋 (6b) 的組合構成了微創插入系統。
- 矽膠蓋連接插入器錐形端與套管遠端之間的間隙。
- 微創插入系統用於使用 Seldinger 技術來放置 Tracoe Twist Plus 氣切套管。

(7-7b) 聲門下抽取通道：

- Tracoe Twist Plus Extract 氣切套管 (REF 316-P、REF 888-316-P) 在氣切套管外側有一個聲門下抽取通道 (7)，抽吸口放置在氣囊上方盡可能低的位置。
- 抽取通道的近端包括一個標準母魯爾連接器 (7a) 埠，用於連接聲門下抽取的外部配件裝置，或用於 ACV 的空氣/氣氣供應。對於聲門下抽取，可以使用額外的轉接器 (II) 連接。
- 可使用附加的蓋子關閉聲門下抽取口 (7a)。

(8) 閉塞器：

- 閉塞器 (8) 在遠端有光滑、圓形的錐形尖端。閉塞器用於重新插入用於氣管造口的氣切套管。
- 由於其具有穿孔，閉塞器可以與 Seldinger 技術一起使用。

(9-9a) 內管：

- REF 311-P 和 REF 316-P 型號附帶 2 個內管，其中一個已預先安裝在外管中。
- 開窗式型號 REF 312-P 和 REF 888-316-P 附帶 3 個內管，其中一個已預先安裝在外管中。
- 每個內管都有一個帶有鎖環 (4) 的 15 mm 連接器。藍色鎖環表示開窗式內管 (9)，白色環表示非開窗式內管 (9a)。
- REF 311-P 和 REF 316-P 包含 2 個非開窗式內管。
- REF 312-P 和 REF 888-316-P 含有 1 個開窗式內管和 2 個非開窗式內管。
- 標準化 15 mm 連接器 (3) 永久地連接到內管，並用於以標準化 15 mm 母連接器將氣切套管與外部裝置連接，例如連接到機械通氣裝置、HME、發音閥。

(12) 頸帶：

- 頸帶 (12) 是一條柔軟的帶狀軟布，包裹在患者的頸部。
- 帶子的兩端包括黏扣帶，通過頸部法蘭的小孔插入，來固定氣切套管的位置。
- 更換頻率由醫生或醫護人員決定。

(13) 凝膠潤滑劑

- 凝膠潤滑劑 (13) 可用於利用微創插入系統或閉塞器插入套管。

補充產品：

- 可與 Tracoe Twist Plus 氣切套管結合使用的產品列於「補充產品」一節。

3. 磁共振 (MRI) 安全資訊



REF 311-P、REF 312-P、REF 316-P 和 REF 888-316-P

非臨床測試證明，Tracoe Twist Plus 氣切套管 REF 311-P、REF 312-P、REF 316-P 和 REF 888-316-P 是「MR 限制條件下安全」。使用此器材的患者可以在符合以下條件的磁共振系統中進行安全掃描：

- 靜磁場為 1.5 Tesla (T) 或 3.0 T。
- 最大空間場梯度為 1,900 gauss/cm (19 T/m)。
- 最大磁共振系統報告全身平均比吸收率 (SAR) 為 2 W/kg (正常操作模式)，最大全頭比吸收率 (SAR) 為 3.2 W/kg。
- 僅限使用正交驅動發射體線圈。
- 頸部法蘭 (5) 必須使用頸帶 (12) 固定到位。
- 氣切套管氣囊 (2b) 的止回閥必須用醫療膠帶固定在皮膚上，遠離磁共振診斷區域。
- 在非臨床測試中，由止回閥引起的影像偽影在使用梯度回波脈衝序列和 1.5 T 磁共振系統成像時，從止回閥延伸長至 (輻射方向) 107 mm，在 3.0 T 磁共振系統中使用自旋回波脈衝序列成像時，延伸至 113 mm。因此，建議將止回閥貼在患者皮膚上，遠離關注區。

警告：

- 在磁共振成像中使用時：
- 在磁共振環境中，請使用無金屬頸帶將套管牢固固定，以防止可能的移動。
- 使用標準醫療膠帶將止回閥牢固固定在遠離關注區的位置，以防止其在磁共振環境中移動。
- 如果關注區接近充氣閥的位置，磁共振影像品質可能會受到影響。

4. 禁忌症

- 氣切套管：
- 氣切套管不能與發熱裝置一起使用，例如雷射。否則有起火和有毒氣體風險，並且套管可能會損壞。
- 使用發音閥或閉塞帽時，不得將 HVLP 氣囊充氣，反之亦然。
- 新生兒、嬰兒和兒童 (< 12 歲)。

ACV 使用：

- 有新氣管造口 (手術切口後不到 7-10 天) 的患者。
- 上呼吸道的阻塞會抑制氣流，從而抑制發聲能力。
- 阻塞可能導致氣管壓力增加，因此導致肺氣腫的風險。
- 患有手術性肺氣腫或氣管組織感染的患者。
- 正中位的聲帶單側或雙側麻痺患者。

5. 一般注意事項

- 產品與其他醫療器械一起使用時，請遵循各自的使用說明。如有任何問題或需要協助，請聯絡製造商。
- 在所述程序中出現併發症時，必須採取安全預防措施，以便透過替代氣道 (如經喉插套管、喉罩) 提供即時通氣。建議根據困難氣道患者的相應適用指南和標準，例如《困難氣道套管理實務指南》(American Society of Anesthesiologists, 2013 年)。
- 在插管或重新插管之前，必須在患者中建立最佳的氧氣濃度。
- 強烈建議在患者床邊放置一個可隨時使用的備用套管和幾個內管。將備用裝置存放在乾淨和乾燥的條件下。
- 還建議在床邊放置緊急備用裝置，以防發生意外氣切套管變化，例如由於併發症、氣管造口塌陷或類似原因造成的變化。緊急備用裝置應比使用中的裝置小一到兩號。

- 在使用 / 插入之前，應檢查產品的完整性和功能。確認套管無阻塞，氣囊材料無脆裂或破損且可充盈 / 收縮，未打結、撕裂或切割，並且套管與頸部法蘭之間有穩定連接等。如果產品損壞，應更換新產品。
- 開啟前應檢查無菌包裝和外包裝是否有損壞。如果包裝損壞或無意中打開，則不應使用本器材。
- 在放置、使用或移除氣切套管時，請勿用力過度。
- 在與外部裝置連接或斷開時，請勿在氣切套管上不必要施力。這可能會導致氣切套管損壞和 / 或移位 / 脫套管。
- 與外部裝置連接或斷開連接時，請始終將氣切套管固定在 15 mm 連接器的底座。
- 應透過內視鏡檢查開窗位置。
- 如果使用一氧化二氮 (笑氣) 作為麻醉劑，氣囊壓力會發生變化。
- 氣囊充氣系統的所有組件在測量氣囊壓力時必須沒有扭曲和扭結，否則壓力表可能會出現不正確的壓力值。
- 確保用於充盈氣囊的所有允許使用的物品 (例如手持式壓力計) 都是乾淨的 (沒有灰塵、可見顆粒和污染物)。氣囊填充系統的任何阻塞都可能導致氣囊放氣，這將降低通氣效率或防止抽吸。
- 為了避免損壞氣囊並方便插入，應始終確保氣囊在插入前放氣，放氣氣囊朝向頸部法蘭。
- 當壓力計和 / 或連接管連接到已充盈氣囊的填充管線時，氣囊和連接的裝置之間總是會有壓力補償。這將導致氣囊中的壓力略有下降。如有必要，重新調整壓力，直到達到最佳範圍。
- 氣囊內的水分：所有 HVLP 氣囊都具有一定程度的水蒸氣滲透性。因此，冷凝水蒸氣可能在氣囊內累積。如果大量的水無意中進入充盈管線，可能會導致氣囊壓力測量結果不正確，氣囊壓力調整和氣囊放氣不正確。在這種情況下，必須更換氣切套管。
- 更換內管時，始終確保氣囊的充盈管線未位於內管和套管之間，因為它可能會被卡住並受損。
- 在機械通氣、頻繁調整患者位置或操縱套管過程中，內管可能會與外管分離。因此，定期檢查內管的連接。
- 在聲門下抽取期間，確保負壓不會過大，並且不會長時間施加，以避免聲門下區域乾燥。建議間歇抽吸。吸氣後關閉抽吸管線埠的蓋子可減少乾燥效果。由於抽吸管線內累積和 / 或乾燥的分泌物，或在抽吸過量液體時，抽吸管線可能會阻塞。如果抽吸管線堵塞，請按照「聲門下抽取」章節中的說明操作。
- 存放條件不當可能會導致產品或無菌屏障損壞。
- 重要參數應由專業人員定期監測。

6. 警告

- 如果無菌包裝或外包裝已被破壞 / 損壞，例如邊緣裂開、包裝上有孔等，請勿使用本產品。
- 不允許重複處理 (包括再消毒)，這可能會影響產品的材料和功能。本產品僅供一次性使用。
- 不允許調整 Tracoe 產品。Tracoe 對調整後的產品概不負責。
- 取下插入系統後，請確保矽膠蓋仍位於導引管上。如果沒有，則必須立即從導管或氣道中取出矽膠蓋 (放射線不透明)。
- 在最初放置氣切套管時，插入的氣切套管的氣囊充氣時，立即停止經由上呼吸道通氣。這有助於降低氣壓創傷的風險。
- 確保氣囊不會被儀器或尖銳的氣管軟骨刺破。
- 僅在氣管造口應用中使用水溶性凝膠潤滑劑，因為油性凝膠可能會損壞套管。
- 在將凝膠潤滑劑塗抹到閉塞器尖端時，請確保套管不會受阻。
- 插入後查看套管的位置和功能。不正確的放置可能會導致氣管黏膜的永久性損傷或輕微出血。
- 一旦套管就位，請勿移動或移位，否則可能會損壞氣管造口 / 氣管或導致通氣不足。
- 請勿轉動 15 mm 連接器，因為這可能會導致內管在外管內旋轉。這可能會導致供氣中斷或氣切套管脫位。使用鎖環鬆開並重新鎖定內管。
- 切勿使用開窗式內管通氣。
- 為避免損壞氣囊材料，它不應與含有氣溶膠的局部麻醉劑或任何軟膏 (如右旋泛醌醇) 接觸。
- 氣囊壓力長期存在或超過 30 cm H₂O (≈ 22 mmHg) 會對氣管造成永久性損傷的風險。
- 只能用空氣填充氣囊。不要用液體填充氣囊，因為這會導致氣囊壓力峰值超過 30 cm H₂O。
- 氣囊填充不足 (低於 20 cm H₂O) 可能導致通氣不足和 / 或抽吸風險增加。最壞情況下可能導致 VAP (呼吸器相關肺炎) 或抽吸性肺炎。
- 在床上調整患者位置時，請確保患者並未躺在指示氣球上，因為這會增加氣囊壓力，並可能損壞氣管。
- 為了防止氣管造口或氣管損傷，請確保氣囊在插入或取出套管之前放氣 (空)。如果無法使氣囊放氣，請使用一把剪刀切斷充盈管線，並排出空氣。在這種情況下，產品是有缺陷的，必須更換。
- 在搭飛機飛行期間，氣囊壓力可能會發生變化。因此，要確保氣囊壓力得到永久控制。
- 在給氣囊放氣之前，請確保患者的上呼吸道暢通無阻。在適用的情況下，透過抽吸或患者咳嗽清除上呼吸道的任何分泌物。
- 確保正確的魯爾連接器用於填充氣囊 (透明) 和抽吸 (白色)。
- 請確保 ACV 使用正確的魯爾連接器 (白色)。
- 確保氣切套管沒有可能導致輸送氣流減少阻塞物。因此，建議根據個別患者的需要 (例如分泌物量) 定期抽吸通道內的分泌物。
- 過多的黏液分泌可能導致氣切套管脫位。透過定期檢查套管的位置來確保套管的正確放置，並減少因聲門下抽吸分泌物而脫位的風險。
- 僅使用抽吸導管清除患者呼吸道和氣切套管的分泌物。儀器可能會楔入套管中，限制通氣。
- 定期檢查所有連接是否牢固，以防止套管與外部裝置意外斷開，確保有效通氣。
- 保持 15 mm 連接器清潔乾燥。
- 請勿使用未經授權的工具將外部裝置與 15 mm 連接器斷開，因為這可能會讓 15 mm 連接器變形。
- 閉塞帽 / 發音閥只能與放氣的氣囊一起使用，以避免窒息風險。
- 在插入和拔出套管時，可能會出現咳嗽或出血。

7. 副作用

氣切套管使用的典型副作用包括出血、局部壓力、疼痛、狹窄和皮膚刺激 (例如由於濕氣)、肉芽組織、氣管軟化、氣管食管瘻管、分泌物增加和吞嚥困難。如果發生不良事件，請立即聯絡醫療專業人員。

使用 ACV 時，常見的副作用包括增加分泌物、不適、聲音嘶啞、咳嗽、噁心或由於恢復上呼吸道功能 (清潔 / 品嚐 / 說話) 引起的喉部乾燥。

在氣囊放氣試驗期間，可能會出現分泌物增加、不適、聲音嘶啞、咳嗽或噁心的情況。

8. 功能描述

注意：

- 強烈建議在患者床邊放置一個可隨時使用的備用套管和幾個內管。將備用裝置存放在乾淨和乾燥的條件下。
- 還建議在床邊放置緊急備用裝置，以防發生意外氣切套管變化，例如由於併發症、氣管造口塌陷或類似原因造成的變化。緊急備用裝置應比使用中的裝置小一到兩號。
- 在所述程序中出現併發症時，必須採取安全預防措施，以便透過替代氣道 (如經喉插套管、喉罩) 提供即時通氣。建議根據困難氣道患者的相應適用指南和標準，例如《困難氣道套管理實務指南》(American Society of Anesthesiologists, 2013 年)。

8.1 準備套管

這是一種無菌裝置，可在無菌環境中使用。

套管的尺寸和適當長度由醫生決定。

使用前必須立即檢查以下功能：氣囊功能、裝置完整性。如果裝置未能通過初步檢查，請使用新裝置重複此程序。請勿丟棄裝置，並按照「退貨和投訴」一節中的說明操作。

A. 使用微創插入系統時

1. 檢查無菌包裝，確保其完好無損且所有組件齊全。
2. 打開包裝，目視檢查裝置是否有損壞。
3. 確認套管是否沒有阻塞，材料沒有變脆或破損，氣囊完好無損，充氣或抽吸管線未打結，沒有撕裂或切口，套管和頸部法蘭之間的連接穩定。
4. 使用手持式壓力計充氣至 50 cm H₂O (≈ 36.78 mmHg) 的壓力，檢查 HVLP 氣囊是否有漏氣。觀察填充的氣囊 1 分鐘，以檢測是否有減壓/氣囊放氣造成的漏氣。如果氣囊是密封的，使用注射器排出空氣。請勿再拉，例如進入真空。
5. 確認預裝內管的鎖環可以毫無阻力地打開並重新鎖緊。要打開內管的鎖環，請將其逆時針旋轉。要鎖定內管的鎖環，請將其順時針旋轉。然後，請確保鎖環正確鎖緊，並將內管固定在外管內。不要將內管從外管上拔出。

注意：

- 檢查內管的鎖環機構時，請勿移動砂膠蓋，以防止遠端套管與插入器之間的直徑間隙。如果發生移位，可以藉由小心地拉回插入器或導引管來緊固連接處。

6. 檢查預裝的砂膠蓋是否能順利彌補插入器錐形端與套管遠端之間的間隙。如果發現間隙，可以小心地拉回插入器或導引管來緊固連接處。

注意：

- 請勿拆卸預先裝好的氣切套管，該氣切套管由插入系統、導引管、氣切套管和內管組成。
 - 請勿拉扯導引管或砂膠蓋的尖端。務必握住整個插入系統（插入器、導引管）。
7. 然後用豌豆大小的凝膠潤滑劑潤滑砂膠蓋和氣切套管的末端。
 8. 如有必要，可以將頸帶固定在頸部法蘭翼上，以便在插入套管後固定。如果要使用頸帶，則應在手術前將其放置在患者頸部下方。

B. 使用閉塞器重新插入時

按照上述步驟 1-5 操作，具體步驟如下：

6. 確保氣切套管內的閉塞器可以輕易地移入和移出氣管。
7. 將閉塞器置於氣切套管內。
8. 在閉塞器的突出部分和套管的下部（包括氣囊）塗上一層薄薄的凝膠潤滑劑。
9. 如有必要，可以將頸帶固定在頸部法蘭翼上，以便在插入套管後固定。如果要使用頸帶，則應在手術前將其放置在患者頸部下方。

8.2 讓患者做好準備

確保患者在插管或重新插管前立即得到最佳的插管前給氧。

為方便插入，如果可能的話，將患者置於平臥姿勢，頸部充分伸展。

8.3 插入套管

A. 使用微創插入系統時

微創插入系統適用於 Seldinger 技術。

1. 氣管切開的患者已做好插管準備，並已將 Seldinger 導線（包含在 TRACOE Experc Set 中，不包含在 P 套管中）插入氣管造口中。
 2. 將帶有插入系統（插入器、導引管）的氣切套管就地放套在 Seldinger 導線上（見圖 5）。如果使用 Tracoe Seldinger 導線，請務必在導引管末端的導管外部能看到導線上的標記時停止。
 3. 將導管與插入器和導引管一起沿著 Seldinger 導線穿過氣管造口插入氣管。注意保持導管、插入器手柄、導引管和 Seldinger 導線對齊，並用一隻手固定。任何移位都可能導致砂膠蓋與套管之間的間隙，進而導致插入困難或中止。
 4. 輕輕地向前推動套管，直到頸部法蘭與皮膚表面接觸。
 5. 一旦到位，用一隻手固定導管，然後將插入器和導引管與 Seldinger 導線一起拔出，同時將氣切套管保持在氣管內的位置（見圖 6）。
- 如果插入器難以取出，也可以連同內管一起取出。為此，請逆時針旋轉鎖環，即可鬆開內管。如果在取出插入器時拔出了內管，應確保隨後重新插入內管，並順時針旋轉鎖環將其鎖定位。這既可以是已取出插入系統的內管，也可以是備用內管。

注意：

- 插入器仍在氣切套管內時，請勿單獨拉動導引管。始終將插入器與導引管和 Seldinger 導線一起拔出，或先拔出插入器，然後再拔出導引管，將氣切套管留在氣管內。
- 取下插入器後，請確保砂膠蓋仍位於導引管上。如果砂膠蓋從導引管上脫落，請按照以下步驟操作：
 - o 立即檢查氣切套管管腔。如果砂膠蓋留在套管中，則必須立即用備用裝置更換內管。
 - o 如果無法目測到砂膠蓋，建議立即拍攝胸部 X 光片以進行精確定位。由於砂膠蓋具備放射線不透性，因此 X 光片可作為用支氣管鏡取出砂膠蓋做好準備。

B. 使用閉塞器

閉塞器是穿孔的，可以與 Seldinger 導線一起使用。

1. 按照「準備套管」和「讓患者做好準備」章節中所述準備好套管和患者。
2. 將套管（內有閉塞器）插入氣管造口時，握住套管的頸部法蘭，並將閉塞器牢牢地按在 15 mm 連接器上。
3. 輕輕地向前推動套管，直到頸部法蘭與皮膚表面接觸。
4. 用一隻手固定套管，插入後立即取下閉塞器。

8.4 插管後

1. 檢查通過套管的氣道是否暢通無阻，如有必要，調整氣切套管的位置（例如使用支氣管鏡）。
2. 如果需要通氧，請將內管的 15 mm 連接器與呼吸系統連接。
3. 如果合適：透過位於指示氣球的魯爾連接器，用空氣將氣切套管的氣囊充氣。
4. 為了防止套管脫位，請使用頸帶將套管固定在原位。
5. 建議在氣管造口和頸部法蘭之間放置敷料，以防止頸部法蘭下方皮膚受到刺激。
6. 重新檢查氣囊壓力，確保在插入過程中未損壞氣囊。

8.5 氣囊充氣

選項 1：建議使用手持式壓力計來取代標準注射器給氣囊充氣。根據個人的通氣治療情況調整氣囊壓力，並定期檢查。通常，壓力應介於 20 cm H₂O (≈ 15 mmHg) 和 30 cm H₂O (≈ 22 mmHg) 之間。

選項 2：使用 Tracoe Smart Cuff Manager，透過被動控制將氣囊壓力維持在 20–30 cmH₂O 的範圍內。將 Tracoe Smart Cuff Manager 的公魯爾連接器連接到氣切套管止回閥的母魯爾連接器。根據相應的使用說明，使用標準注射器替 Tracoe Smart Cuff Manager 充氣。

注意：

- 在床上調整患者位置時，請確保患者並未躺在指示氣球上，因為這會增加氣囊壓力，並可能損壞氣管。

8.6 連接/斷開外部裝置

要連接到外部裝置或配件（例如呼吸器），請牢牢握住 15 mm 連接器的底座，並輕輕推動外部裝置的連接端，直到它牢固地連接到氣切套管。若有疑問，請多次扭上扭下連接端，以確認所需的力道；確保連接牢固，同時可以在以後輕鬆斷開外部裝置。如果很難斷開，請使用標準化的斷開槓（未提供）將氣切套管與外部裝置或配件分離，方法是在 15 mm 連接器和外部裝置之間滑動斷開槓的開口，直到兩個裝置分離，請參閱「補充產品」章節。

注意：

- 在與外部裝置連接或斷開時，請勿在氣切套管上不必要施力。這可能會導致氣切套管損壞和/或移位/脫套管。

8.7 聲門下抽吸

1. 若要進行間歇抽吸，請取下聲門下抽吸管線魯爾連接器的蓋子。
 - 2a. 可以使用注射器進行手動抽吸。
 - 2b. 可以使用轉接器連接主動抽吸裝置（見圖 2）。
3. 在聲門下抽吸後，用蓋子重新密封抽吸管線魯爾連接器。

注意：

- 如果抽吸通道受阻，可以藉由充空氣/氧氣（建議 3–6 l/min；最大 12 l/min）清除，或者用生理鹽水沖洗（建議 2–3 ml）。不要超過建議的限制，並注意患者的個人耐受性。可能會出現以下副作用：可能受污染的分分泌物積累、不適、噁心和反胃、分泌物過多。
 - 在沖洗抽吸通道之前，請確保氣囊已充分充氣。
 - 沖洗抽吸通道後立即移除使用的生理鹽水。
 - 如果抽吸通道未清潔，則必須更換套管。

8.8 Above Cuff Vocalisation

注意：

- ACV 必須由專業人員執行。

ACV 用於為患者提供聲音功能。因此，必須根據個別患者的需求和能力進行調整。必須提供患者指示，並讓患者參與 ACV 的每個步驟，以確保在應用過程中的合作和良好效果。

在使用 ACV 之前，請確保患者佩戴的是帶有永久充盈氣囊的氣切套管，並且無法忍受氣囊排氣。如果需要，可以在充氣前透過聲門下抽吸管線加濕空氣，這可以防止喉黏膜乾燥。

1. 向患者解釋計劃中的手術程序，指出可能的不良反應並澄清患者的問題。
2. 確認上呼吸道未被阻塞。
3. 使用聲門下抽吸法清除聲門下空間的分分泌物。
4. 確認抽吸通道未被阻塞。
5. 透過指尖連接器將可調節的空氣或氧氣供應連接到聲門下抽吸管線的母魯爾連接器。或者，可以使用用於中斷永久氣流的其他裝置（例如 Y 型連接器）。
6. 向患者的上呼吸道緩慢充氣，從 1 l/min 開始，根據患者的要求，慢慢上升到 3–6 l/min 的典型流量。為減少喉黏膜乾燥，流速不得超過 12 l/min。使用指尖連接器來限制空氣流動時間。此時間範圍應該根據患者的呼吸節奏調整。在患者舒適區內調整氣流和時間。
7. 監測患者的反應，並根據需要調整參數（氣流流量和時間）。
8. 療程結束後，關閉氣流並斷開裝置與聲門下抽吸管線連接器的連接，並更換蓋子。

注意：

- 通過上呼吸道的氣流可能會刺激患者，或者可能導致分泌物增加、咳嗽、噁心或嘔吐。
- 如果聲音聽起來沙啞，請重複聲門下抽吸以清理氣道。
- 根據患者的能力/耐力調整單次 ACV 療程的持續時間。
- 使用短期 ACV 以防止喉黏膜乾燥。
- 經過醫療訓練的工作人員定期監測有氣管造口的患者。

8.9 氣囊放氣

在將氣囊放氣之前，請確保儘可能少的分泌物進入下呼吸道，例如透過聲門下抽吸和/或透過套管抽吸。若要將氣囊放氣，請將針筒（柱塞已推入）連接到先導止回閥的母魯爾連接器上。將柱塞向後拉，直到從氣囊中取出空氣。請勿再拉，例如進入真空。在移除氣切套管之前，氣囊必須放氣（空）。

注意：

- 從氣囊移除空氣時，要注意清除空氣的體積。這可以作為進一步氣囊充氣時的系統完整性的參考。

8.10 更換內管

如果鬆稠的分泌物聚集在內管中且無法吸出，從而阻礙氣流，請用新的或清潔的內管替換原內管。

1. 逆時針旋轉鎖環，鬆開內管，然後將其取出。
2. 如果產品損壞，請勿進一步使用內管，請勿丟棄內管，並按照「退貨和投訴」章節中的說明進行操作。
3. 一旦新的內管插入外管，順時針旋轉鎖環，直到卡入到位將其鎖定。

注意：

- 插入內管時，始終確保氣囊的充盈管線未位於內管和內管之間，因為它可能會被卡住並受損。

8.11 拆卸套管

如需更換套管材料，請按照「準備套管」章節所述準備更換套管。在取出套管之前，請按照「讓患者做好準備」章節中所述為患者做準備。

1. 給氣囊放氣（見「給氣囊放氣」章節）。
2. 固定頸部法蘭，同時鬆開頸帶。
 3. 牢牢抓住頸部法蘭，輕輕從造口中拉出氣切套管。如有必要，透過套管抽吸分泌物可能有助於防止浸潤到下呼吸道。
4. 拆卸後，應盡快清洗套管，以防止液體結垢。
5. 如果產品損壞，請勿進一步使用套管，請勿丟棄套管，並按照「退貨和投訴」章節中的說明進行操作。如需更換套管，請在卸下套管後按照「插入套管」、「套管插入後」、「氣囊充氣」和「連接/斷開外部裝置」章節中的說明操作。

9. 保養和清潔

注意：

- 從最初打開無菌屏障開始，本裝置的使用時間不應超過 29 天。
- 微創插入器和導引管是一次性使用的，不允許清潔和重複使用。
- 此最長使用期間包括患者和非患者（例如清潔）使用本裝置。
- 為了衛生起見，並且為了避免在事後重新組裝套管時發生混淆，必須將外管與相應的內管一起清潔。
- 在重新插入之前，應檢查產品的完整性和功能

清潔氣切套管和閉塞器是為了清除任何可能妨礙其臨床使用的體液或結垢。

請注意在清潔後，應握住外管的頸部法蘭、內管的 15 mm 連接器處以及閉塞器的手柄處。

以下手動清潔指示適用於所有 Tracoe Twist Plus 型號和尺寸：

1. 將內管從外管上鬆開
2. 要清潔套管（外管和內管）和閉塞器，請在溫水（最高 40°C/104°F）中分開清洗裝置，直到它們明顯乾淨且沒有結垢。
3. 應特別注意確保徹底沖洗套管內部，並視情況徹底沖洗聲門下抽吸套管。
4. Tracoe 提供的刷子或棉花棒可用於去除殘留的碎屑，請參閱「補充產品」。
5. 或者，可以按照各自的使用說明使用 Tracoe 清潔產品（見「補充產品」）。
6. 清潔後，用飲用水或蒸餾水沖洗套管。
7. 如果沖洗後，目視套管仍不乾淨：
 - 重複沖洗，直至明顯清潔，或
 - 使用 Tracoe 清潔產品重複清潔，或
 - 安全地丟棄氣切套管。
8. 應在光線充足的情況下檢查套管和閉塞器的所有區域，以確保器械沒有污染和結垢。
9. 在清潔過程完成後，將套管和閉塞器放在乾淨、無絨毛的乾毛巾上，並在沒有空氣污染的区域風乾。
10. 目視外管、內管和閉塞器在沒有殘留水時即視為乾燥。請檢查氣囊內部是否乾燥。
11. 最後，在重新插入之前應進行目視和功能檢查，以確認套管和閉塞器沒有損壞（另請參閱「準備套管」章節）。

注意：

- 氣切套管（外管和內管）和閉塞器應在從造口取出後立即清潔，以防止泥污和污染物的乾燥。
- 清潔時，請注意不要損壞氣囊或充盈管線。
- 將帶氣囊的套管浸入清潔試劑溶液中時，建議不要將指示氣球浸入溶液中。
- 清潔頻率必須由醫生確定，但不得超過允許的頻率。
- 建議每天清潔氣切套管。29 天內的最大允許清潔週期為外管 29 次、內管 35 次，否則可能會損害生物相容性和材料穩定性。
- 切勿使用本說明書中未指定的清潔劑或程序清潔套管。
- 氣切套管僅供單一患者使用。因此，必須將其送回給同一位患者。
- 未正確清潔裝置可能會導致套管損壞，由於阻塞而增加空氣阻力，或氣管造口的刺激/炎症。
- 由於上呼吸道從來沒有微生物，即使是健康人，我們也不建議使用消毒劑。

10. 存放

- a) 根據包裝上顯示的條件將 Tracoe 產品存放在其原包裝中。不要將產品加熱到 60°C 以上的溫度。
- b) 將清潔的氣切套管存放在乾淨的容器中並蓋上蓋子，將容器儲存在乾淨且乾燥的地方，並避免陽光照射。儘快重新插入氣切套管。存放條件不當可能會導致套管損壞或污染。自首次使用起，清潔過的裝置的存放時間不得超過 29 天。

11. 包裝

本產品提供無菌（環氧乙烷滅菌），可在無菌條件下使用。Tracoe 氣切套管在正常使用或清潔期間不需要無菌環境。

12. 處置

使用過的产品應根據國家法規、廢棄物管理計劃或生物危害性廢棄物材料的臨床程序進行處置，例如直接丟棄在防撕裂和防潮的安全袋或容器中，並將其送往當地可處理受污染醫療產品的廢棄物處理系統。如需進一步建議，請聯絡您所在醫療機構的衛生主管，或者聯絡當地的家庭護理廢棄物管理部門。

13. 退貨和投訴

如果您想對本器材提出投訴，請聯絡 complaint.se@atosmedical.com。如果涉及當地醫療器械法律中定義的可通報事件，請與使用國家/地區的相關監管機構聯絡。

14. 補充產品

配備微創插入系統的 Tracoe Twist Plus 氣切套管也可作為 Tracoe Experc Set 與 Tracoe Experc Dilatation Set 搭配使用。

Tracoe Seldinger 導絲是上述套件的一部分。也可以單獨提供，可附帶或不附帶導引管。

14.1 推薦產品：

- Tracoe Twist Plus 備用內管
- 帶標準公魯爾連接器的注射器
- 適用於 HVLP 氣囊的氣囊壓力監測器（帶標準公魯爾連接器）
- Tracoe Smart Cuff Manager
- 用於氣管造口術的無菌水溶性凝膠潤滑劑
- 頸帶

- 斷開氣管切開 / 氣管內管的楔子與 15 mm 連接器的連接
- 溫濕交換器 (HME) 與標準 15 mm 公連接器

14.2 可選產品：

- 帶有標準 15 mm 公連接器的發音閥和閉塞帽
- Tracoe 提供的清潔劑
- Tracoe 提供的清潔配件（例如棉花棒、刷子、浴盆）
- Tracoe 水霧護罩

- 敷料和敷藥
- 防護紡織品（例如圍兜、圍巾、高領）

15. 一般條款和條件

所有 Tracoe 產品的銷售、交付和退貨應僅根據有效的一般條款和條件 (GTC) 進行，這些條款和條件可從 Tracoe Medical GmbH 或網站 www.tracoe.com 取得。

Symbols

	Manufacturer; 製造商
	Country of manufacture with date of manufacture; 製造國家/地區和製造日期
	Use-by date; 使用截止日期
	Batch Code; 批次代碼
	Medical Device; 醫療裝置
	Instructions for use; 使用說明
	Caution, consult instructions for use; 注意事項，參閱使用說明
	Federal (USA) law restricts this device to the sale by or on the order of a physician
	Single Patient - multiple use; 單一患者：多次使用
	Sterilized using ethylene oxide; 使用環氧乙烷滅菌
	Do not resterilize; 禁止反復滅菌
	Do not use if package is damaged; 若包裝受損，請勿使用
	Peel here; 從此處撕開
	Keep away from sunlight and keep dry; 避免日照並保持乾燥
	Storage temperature limit; 儲存溫度限制
	Single sterile barrier system; 單一無菌屏障系統
	Single sterile barrier system with protective packaging outside; 具有外部保護包裝的單一無菌屏障系統
	Not made with phthalates (e.g. DEHP); 非由鄰苯二甲酸酯（例如 DEHP）製成
	Not made with Natural Rubber latex; 非天然橡膠乳膠製品
	Packaging Content; 包裝內容
	MR conditional; MR 限制條件下安全
	Triman symbol and Infotri for France; 法國 Triman 標誌和分類中心
	Packaging is recyclable; 包裝可回收
	Recycling guidelines; 回收指引
	Fenestration; 開窗
	Low-pressure cuff; 低壓氣囊
	Suction line; 抽吸管線
	Minimally-traumatic inserter; 微創插入器